

Design of the hydraulic shock absorbers characteristics using the acceleration of the sprung mass

P. Polach^{a,*}, M. Hajžman^a

^a Section of Materials and Mechanical Engineering Research, ŠKODA VÝZKUM s.r.o., Tylova 1/57, 316 00 Plzeň, Czech Republic

Received 6 September 2007; received in revised form 25 September 2007

Abstract

The force-velocity characteristics of the air-pressure-controlled shock absorbers produced in BRANO a.s. were designed on the basis of the relative deflections of the air springs. These characteristics are verified by means of another approach – the acceleration of the sprung mass criterion. The reference vehicle is the same as in the previous case – the SOR C 12 intercity bus. The bus multibody models created in the *alaska* simulation tool are used for the designed characteristics verification. The results of both approaches are compared.

© 2007 University of West Bohemia. All rights reserved.

Keywords: vehicle dynamics, multibody model, controlled shock absorber, acceleration, bus

1. Introduction

In 2003, in order to improve the dynamic properties of buses and heavy vehicles, BRANO a.s., the producer of shock absorbers for those types of vehicles, started to develop the semi-active hydraulic telescopic shock absorbers controlled by air pressure. The SOR C 12 intercity bus (see fig. 1), produced by SOR Libchavy spol. s r.o., was the reference vehicle, for which the research and development of the shock absorbers was done and on which the shock absorbers were verified. The main question was which force-velocity characteristics of the shock absorbers could be appropriate for different weights of the vehicle. The answer was found out using the results of the computer simulations with the bus multibody models.

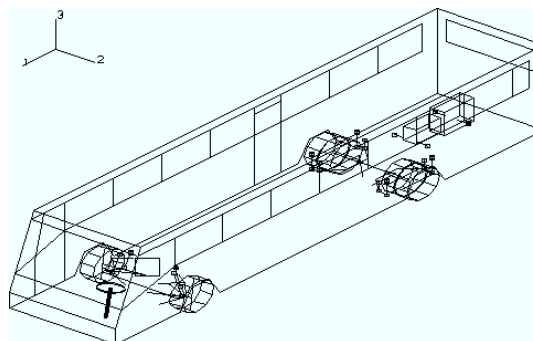

Fig. 1. The SOR C 12 intercity bus – the real vehicle and the multibody model visualization.

As a criterion for the design of the optimum force-velocity characteristics of the semi-active air-pressure-controlled shock absorbers (APCSA) maximum similarity of dynamic responses of the multibody models of the SOR C 12 bus for all the considered weights to dy-

* Corresponding author. Tel.: +420 378 182 246, e-mail: pavel.polach@skodavyzkum.cz.

dynamic response of the reference multibody model was chosen. Time histories of the relative deflections of the axles air springs determined during the simulations were originally compared [9], [10]. Verification of the suitability of the designed force-velocity characteristics of the APCSA described in this article is evaluated according to other approach – keeping acceleration of the sprung mass within reasonable limits from the point of view of a driver (e.g., [3], [12]).

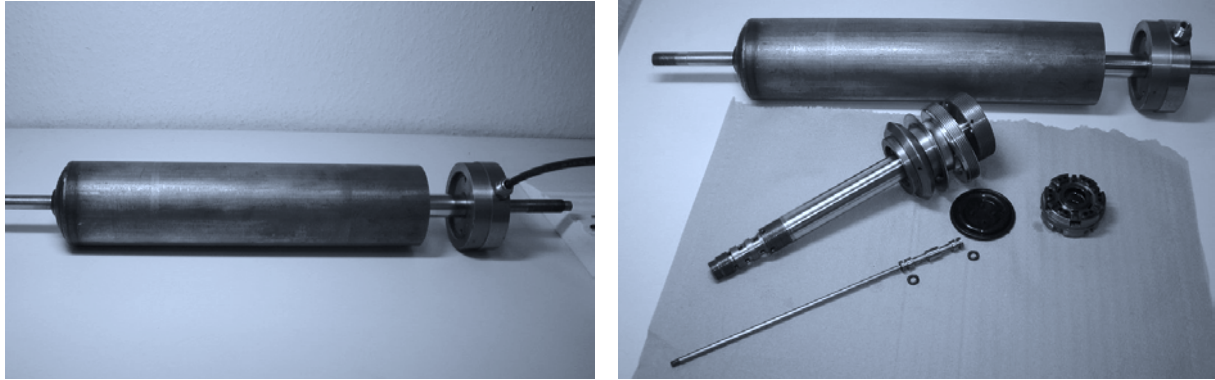

Fig. 2. The air-pressure-controlled hydraulic shock absorber and its structural members.

Multibody simulations had already been used for developing and improving damping properties of the vehicle's suspension. Many articles deal with the optimum damping properties with respect to the ride comfort of the driver and passengers. The special approximation concept [4] is proposed and used for the design of a stroke-dependent damper. The ride comfort of a heavy truck is also improved in [5] using RMS values of accelerations as the objective function. The principles of the shape optimization were used for the suspension design with respect to the optimum ride comfort and riding safety in [2]. A real time damper system suitable for the optimum vehicle handling properties was proposed in [1]. Road friendliness can be another criterion in the suspension design. For that purpose a dynamic load stress factor leading to the improvement of road-tire forces is used in [12].

In comparison with the above mentioned selected articles, in which the optimal behaviour was characterized by the minimization of some chosen variables, the optimal behaviour of the shock absorbers in the case of the APCSA of the axles' air suspension of the SOR C 12 intercity bus was determined directly by the producer. For the design of the force-velocity characteristics of the APCSA (that should lead to the defined optimal dynamic behaviour of the vehicle) the objective function was proposed and used in [9], [10].

The aim of the work is to verify the originally designed force-velocity characteristics of the APCSA of the SOR C 12 intercity bus [9], [10].

2. Multibody models of the SOR C 12 intercity bus

Force-velocity characteristics of the APCSA of the axles' air suspension of the SOR C 12 intercity bus are designed on the basis of the results of computer simulations with the bus multibody models (see fig. 1) created in the *alaska* simulation tool [6].

Multibody models of an empty, a fully loaded and three variants of a partly loaded vehicle were created. For the buses of all the weights, a basic multibody model and a multibody model with more precise kinematics of the axles suspension were created [8]. Creation of relatively simple multibody models (in this case of the basic multibody model) and an effort to improve them is important due to the significant shortening of the computational time.

The empty, the fully loaded and two variants of multibody models of the partly loaded bus (20 % and 50 % of the maximum load) were created and intended for the design of the force-velocity characteristics of the APCSAs for those states of the vehicle load. Optimal setting of the force-velocity characteristics of the non-controlled shock absorbers of the SOR C 12 bus loaded to 71.5 % of the maximum load was the result of the operational tests at the airport in Hořkovice in September 2004. This optimal setting of the force-velocity characteristics of the non-controlled shock absorbers was performed taking into account the BRANO a.s. testing engineers' experience. On the basis of the records of the experimental measurements documented in [7], the created multibody models of the SOR C 12 bus loaded to 71.5 % of the maximum load were verified at the same time.

The multibody models of the SOR C 12 intercity bus and possible simulated operational situations are described in [8], [9] or [10].

3. The methodology of the verifying the optimum force-velocity characteristics design of the controlled hydraulic shock absorbers

As a criterion for the verifying of the design of the optimum force-velocity characteristics of the APCSAs (fig. 2) maximum similarity of time histories of the vertical acceleration at the chassis under the driver's seat of the multibody models of the SOR C 12 bus for all the considered weights to the time history of the vertical acceleration at the chassis under the driver's seat of the reference multibody model was chosen. The reference multibody model was the bus model with the same load as during the experimental measurements with the real vehicle at the airport in Hořkovice.

3.1. Parametrization of the problem

In the case of tuning the force-velocity characteristics of shock absorbers it is evident that the design parameters are the quantities defining the course of the force-velocity characteristics. The force-velocity characteristics of the non-controlled shock absorbers of the SOR C 12 bus (see fig. 3) used in the computer simulations were obtained by measuring on a special test stand under the specific operational conditions. After processing the measurement, the dependence of the damping force F in the shock absorbers on the relative velocity of the shock absorber rebound and compression v was available.

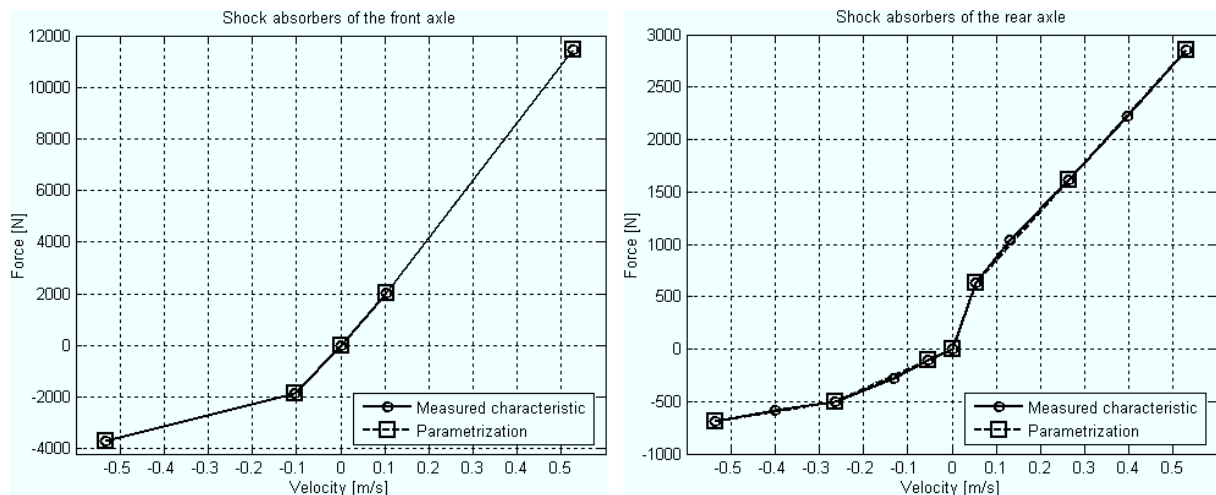

Fig. 3. The force-velocity characteristics of the non-controlled shock absorbers of the front and rear axles of the SOR C 12 intercity bus and their parametrizations.

The values of the measured forces F , which will be changed during the tuning process, were chosen to be the design parameters (like in [9] or [10]). In practice it is not suitable to choose too many points because it is not possible to design a hydraulic shock absorber with too complicated course of the force-velocity characteristic. The requirement for the relatively small number of points of the characteristic as the design parameters is also suitable regarding the optimization computational time. The design parameters are arranged into the vector $\mathbf{p} = [F_1, F_2, \dots, F_N]^T$.

The measured five-point force-velocity characteristic of the front axle hydraulic shock absorbers was parametrized in all the non-zero points (see fig. 3). The original measured eleven-point characteristic of the rear axle hydraulic shock absorbers (in fig. 3, a full line with circular markers) included too many points the position of which could be tuned for the optimization process. That is why the original characteristic was reduced to a seven-point one (in fig. 3, a dashed line with square markers). The point [0,0] of the characteristics was constant because it is obvious, that for zero velocity zero force must act in the shock absorbers. The facts that both the shock absorbers of the front axle suspension have identical force-velocity characteristics and that all four shock absorbers of the rear axle suspension also have identical characteristics were respected in the optimization process.

3.2. Choice of an objective function

The specification of the objective function, which should clearly quantify the degree of the objective achievement, is a further step in solving the problem. At first it had to be decided for which operational situation the force-velocity characteristics of the APCSA would be optimized: simulations of running over an obstacle (modified obstacle according to ČSN 30 0560 Czech Standard at bus speed 40 km/h) with all the wheels, i.e. the same simulations as in [9] or [10], were chosen.

Dynamic responses of the vehicle from the moment immediately prior to running up the obstacle with the front wheels (3.5 second) to 10 seconds of the simulation (practically decay of the responses) were compared. Time histories of the vertical acceleration at the chassis under the driver's seat were the compared quantities.

The approach based on the calculation of the statistical quantities that express directly the relation between two time series was chosen (like in [9] or [10]) for the design of the force-velocity characteristics of the APCSA.

The correlation coefficient $R(\mathbf{p})$ defined for two discrete time series $x^{(1)}$ (the vertical acceleration at the chassis under the driver's seat of the bus loaded to 71.5 % of the maximum load) and $x^{(2)}(\mathbf{p})$ (the vertical acceleration at the chassis under the driver's seat of the bus of other examined weights, function of design parameters) [11] was calculated

$$R(\mathbf{p}) = \frac{\sum_{i=1}^n (x_i^{(1)} - \mu_1) \cdot [x_i^{(2)}(\mathbf{p}) - \mu_2(\mathbf{p})]}{\sqrt{\sum_{i=1}^n (x_i^{(1)} - \mu_1)^2 \cdot \sum_{i=1}^n [x_i^{(2)}(\mathbf{p}) - \mu_2(\mathbf{p})]^2}}, \tag{1}$$

where μ_1 and $\mu_2(\mathbf{p})$ are the mean values of the appropriate time series. The correlation coefficient values range between zero and one. The more the compared time series are similar to each other, the more the correlation coefficient tends to one. The advantage of the correlation coefficient is that it quantifies very well the similarity of two time series by scalar value, which is obtained by a simple calculation. In order to verify the designed force-velocity char-

acteristics of the APCSA the problem was formulated (like in [9] or [10]) as the minimization of the objective function

$$\psi(\mathbf{p}) = [1 - R(\mathbf{p})]^2. \quad (2)$$

3.3. The optimization procedure

If the problem is parametrized and if the objective function is defined, it is necessary to choose the appropriate optimization method. In case of the computer simulations with the multibody models of the SOR C 12 intercity bus [8] in the *alaska 2.3* simulation tool [6], the whole process of the optimization is limited by the impossibility of executing the analysis

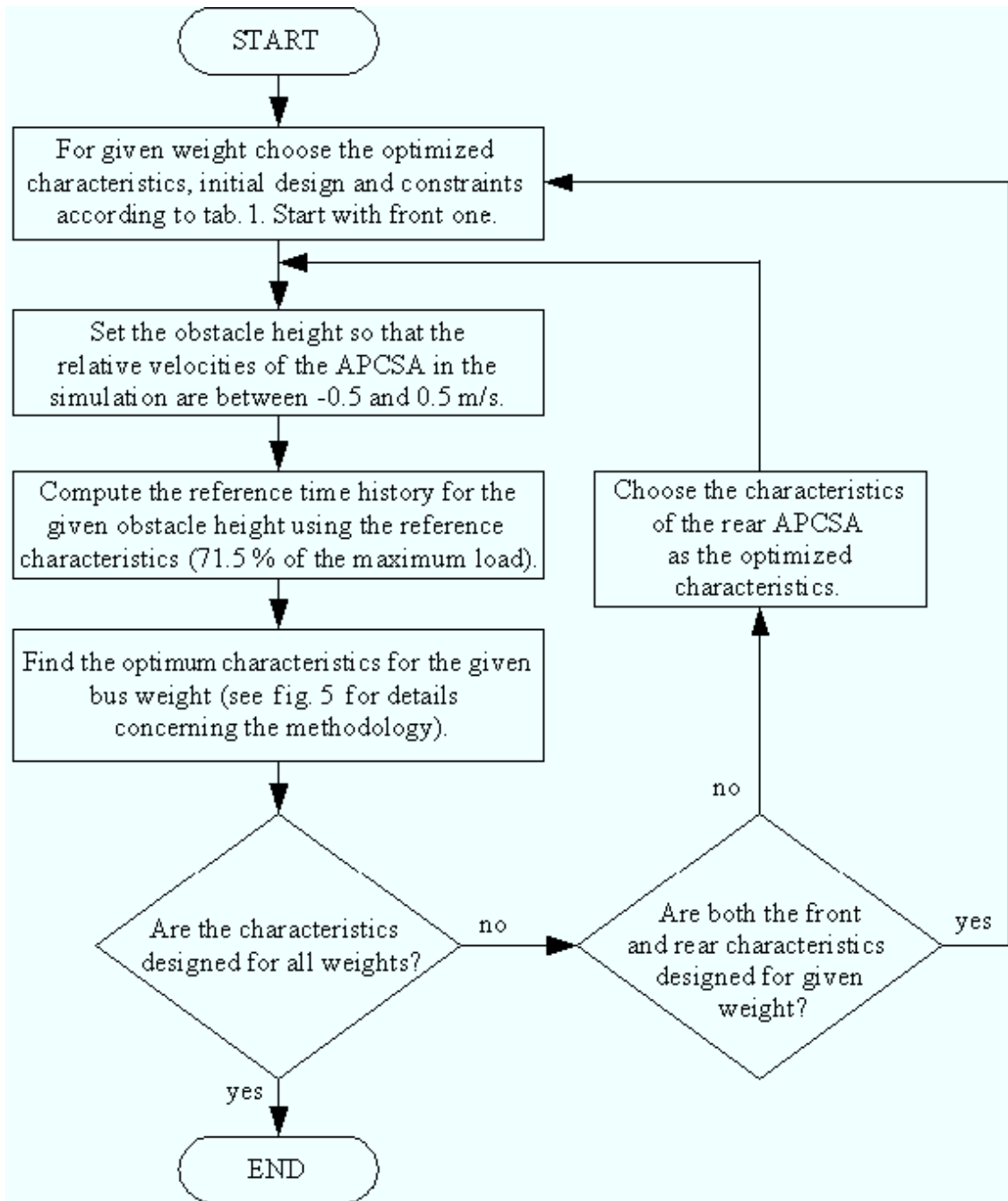

Fig. 4. The methodology of the design of the APCSA optimum characteristics.

from the command line and evaluating the results of numerical simulations without the necessary human intervention. “Manual” change in the parameters on the basis of the chosen optimization method is the only solution. Due to the shorter computational time the basic multi-body models of the SOR C 12 bus [8] are chosen for the numerical simulations (it followed from the test calculations, [9] and [10] that the suitability of the designed characteristics is not negatively influenced by this choice).

The whole optimization procedure is summarized in figs. 4 and 5. The methodology can be divided into two main loops. The first one is shown in fig. 4 and together with tab. 1 it

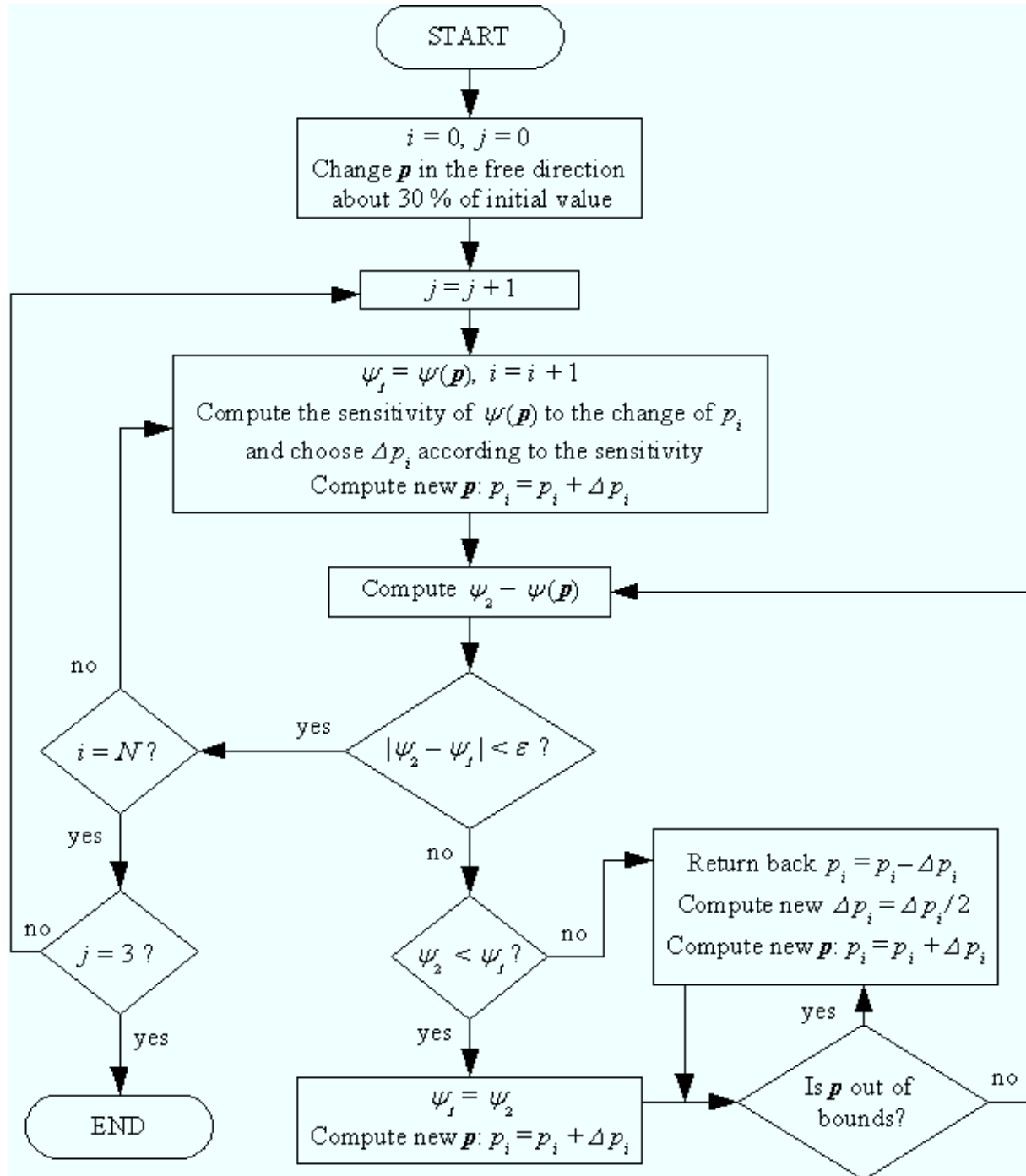

Fig. 5. The optimization methodology for the design of the APCSA characteristics for the given bus weight.

describes the procedure of the subsequent selection of the characteristics and their design for the particular bus weights. The initial designs and the constraints defining bounds in the optimization process are written in tab. 1. The second inner loop is shown in fig. 5 and illustrates the design procedure for the given force-velocity characteristic of the APCSA.

Step	Optimized force-velocity characteristics for bus weight	Initial design	Constraints
1 st	Fully loaded	71.5 % of maximum load	71.5 % of maximum load (lower bound for $v > 0$, upper bound for $v < 0$)
2 nd	50 % of the maximum load	71.5 % of maximum load	71.5 % of maximum load (upper bound for $v > 0$, lower bound for $v < 0$)
3 rd	20 % of the maximum load	Optimum design for 50 % of the maximum load	Optimum design for 50 % of maximum load (upper bound for $v > 0$, lower bound for $v < 0$)
4 th	Empty	Optimum design for 20 % of the maximum load	Optimum design for 20 % of maximum load (upper bound for $v > 0$, lower bound for $v < 0$)

Tab. 1. The initial designs and the constraints defining bounds in the optimization process of the force-velocity characteristic of the APCSA.

In order to guarantee that the optimized force-velocity characteristics may be applied in the whole range of the required operational velocities (approx. between -0.5 m/s and 0.5 m/s), the height of the artificial obstacle during the particular cycles (see fig. 4) were changed in such a way that the extremes of the time histories of the shock absorbers velocities may get closer to the required limits. Operational velocities of the shock absorbers were given on the basis of the producer’s demands. Limit velocities, for which the producer is able to guarantee their damping properties on the basis of the customers’ requirements, are concerned. The specific used obstacle heights in the optimization of the force-velocity characteristics of the shock absorbers for the various bus weights are summarized in tab. 2.

Bus weight	Obstacle height in tuning	
	The force-velocity characteristics of the front axle shock absorbers	The force-velocity characteristics of the rear axle shock absorbers
Empty	0.023 m	0.014 m
20 % of the maximum load	0.023 m	0.014 m
50 % of the maximum load	0.025 m	0.014 m
Fully loaded	0.025 m	0.014 m

Tab. 2. Summary of the used obstacle heights in tuning the force-velocity characteristics of the shock absorbers.

In order to automatically calculate the correlation coefficient and compare two numerical time series of the same length, the in-house software was programmed in the MATLAB system [13].

Fig. 6 shows the example of the time histories of the vertical acceleration at the chassis under the driver’s seat in the course of optimizing the force-velocity characteristics of the front axle shock absorbers, fig. 7 shows the example of these time histories in the course of optimizing the force-velocity characteristics of the rear axle shock absorbers.

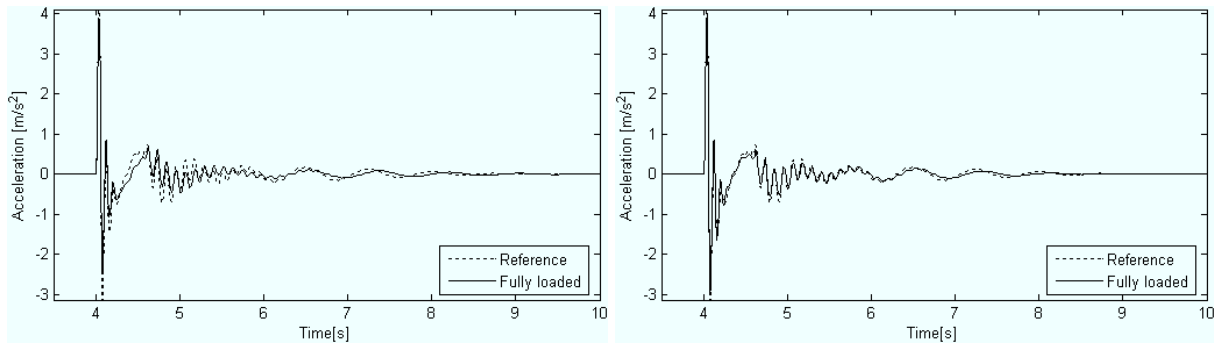

Fig. 6. Time histories of the vertical acceleration at the chassis under the driver’s seat of the fully loaded bus and of the bus of the reference load (comparison of the reference case with the original and optimally tuned force-velocity characteristics after the optimization of the front APCSA).

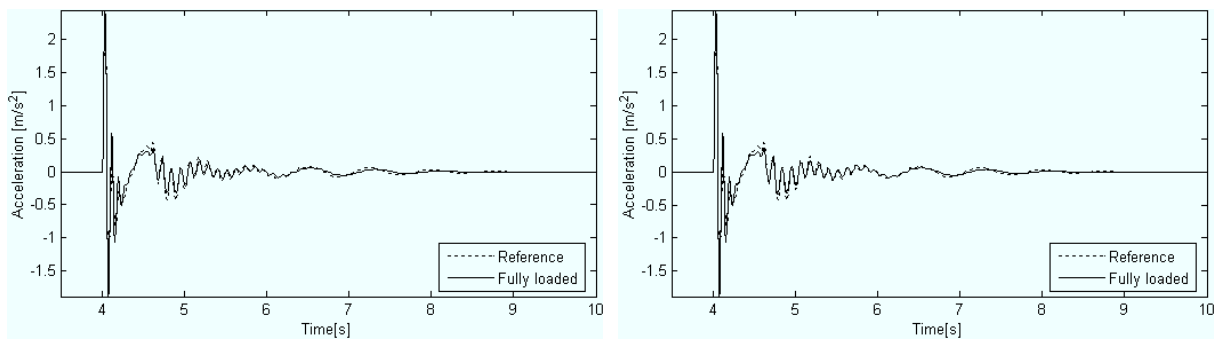

Fig. 7. Time histories of the vertical acceleration at the chassis under the driver’s seat of the fully loaded bus and of the bus of the reference load (comparison of the reference case with the original, i.e. after the optimization of the front APCSA, and optimally tuned force-velocity characteristics after the optimization of the rear APCSA).

4. Force-velocity characteristics of the air-pressure-controlled shock absorbers of the SOR C 12 bus

The optimum force-velocity characteristics of the APCSA of the SOR C 12 bus axles suspension for the various vehicle weights were designed during the simulations with the basic bus multibody models using the described methodology. The design of the force-velocity characteristics was finished during the simulations with the bus multibody models with more precise kinematics of the axles suspension. As it was written above (and verified – [9], [10]), the multibody models’ complexity did not influence significantly the course of the designed optimum force-velocity characteristics of the APCSA of the SOR C 12 bus axles suspension.

From comparing the originally designed [9], [10] and the verified force-velocity characteristics of the APCSA of the front and rear axles of the SOR C 12 intercity bus in figs. 8 and 9 (the characteristics are linearly interpolated between the points in which the characteristics were tuned) it is evident that the verified force-velocity characteristics have less variance of points for the various vehicle weights than the originally designed force-velocity characteristics (exception is compression field of the force-velocity characteristics of the APCSA). Especially in the rebound field the verified characteristics for the bus weight lower than the reference weight differ only minimally.

In the verified force-velocity characteristic of the rear axle shock absorbers of the fully loaded bus at speed 0.264 m/s a certain singularity is partly suppressed in comparison with the originally designed force-velocity characteristic [9], [10] – see fig. 9.

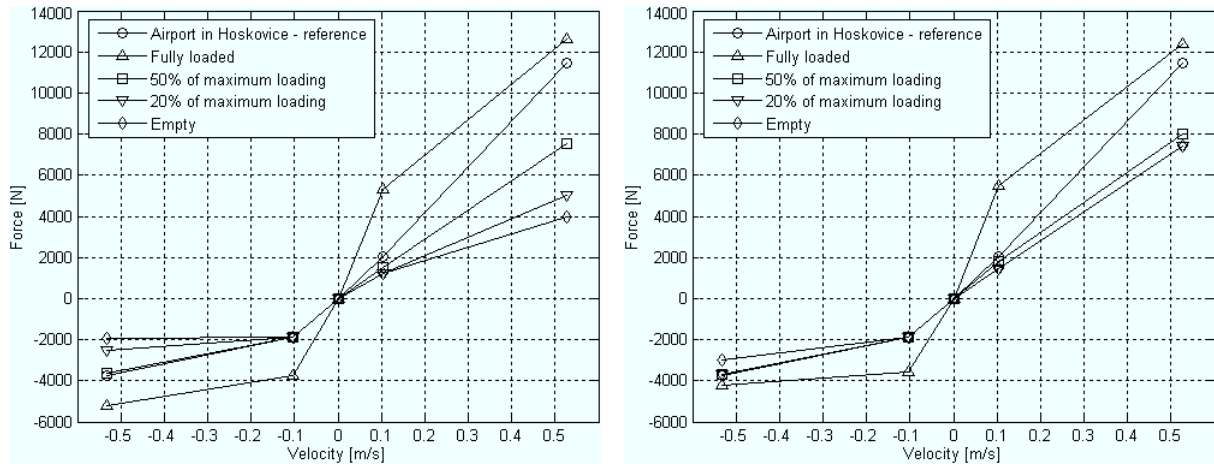

Fig. 8. The originally designed [9], [10] and the verified force-velocity characteristics of the APCSA of the front axle of the SOR C 12 intercity bus.

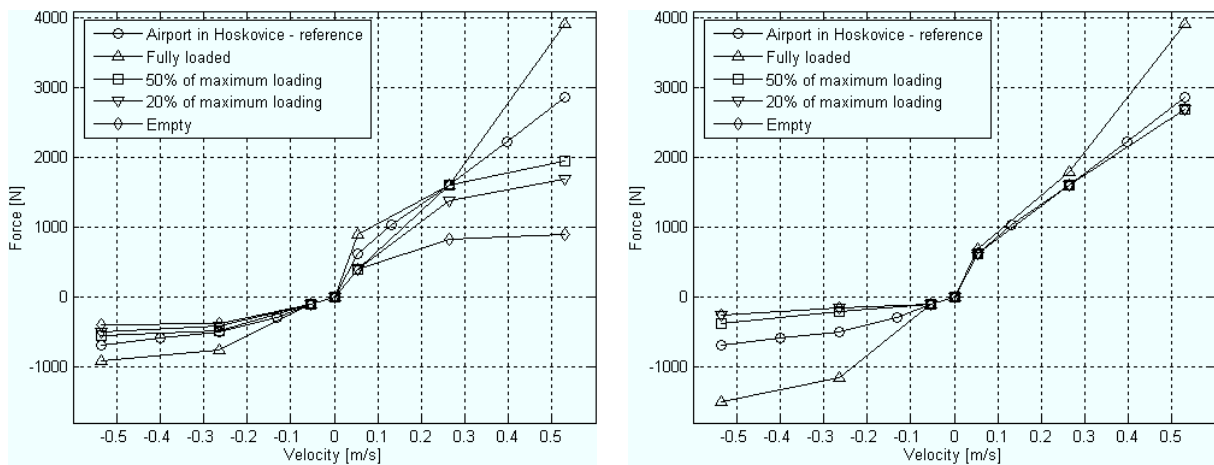

Fig. 9. The originally designed [9], [10] and the verified force-velocity characteristics of the APCSA of the rear axle of the SOR C 12 intercity bus.

5. Conclusion

The modified methodology for the design of the force-velocity characteristics of the semi-active air-pressure-controlled shock absorber (APCSA) described in [9], [10] is used for the verification of the originally designed force-velocity characteristics of the APCSA of the axles air suspension of the SOR C 12 intercity bus. Instead of monitoring and comparing the time histories of the relative deflections of the air springs the time histories of the vertical acceleration at the chassis under the driver's seat are monitored and compared.

The designed force-velocity characteristics of the APCSA of the SOR C 12 bus were verified on the basis of the results of the computer simulations performed with the bus multibody models [8] created in the *alaska* simulation tool [6]. The values of the damping forces in the selected points of the force-velocity characteristics of the non-controlled shock absorbers were the design parameters of the optimization problem. Running over the vertical artificial obstacle with all the wheels at the bus speed 40 km/h was the selected simulation for the force-velocity characteristics of the APCSA tuning. The correlation coefficient between the dynamic responses of the vehicle under the reference load (the bus loaded to 71.5 % of the maximum load) and the vehicle under the other loads was used as a suitable criterion for the evaluation of the responses similarity.

When comparing the time histories of the vertical acceleration at the chassis under the driver's seat, the sensitivity of the force-velocity characteristics of the APCSA to the vehicle weight is less than when comparing the time histories of the relative deflections of the air springs. The cause of this phenomenon is probably the fact, that only one monitored quantity (at the front part of the bus) is compared, while in case of the monitoring the time histories of the relative deflections of the air springs two monitored quantities were evaluated (one in the front air spring and one in the rear springs). It is necessary to mention that the approach to the design of the force-velocity characteristics on the basis of the vertical acceleration at the chassis under the driver's seat can be improved. As it is given in [3], the vertical acceleration at the chassis under the driver's seat does not exactly reflect the real influence on the human body on the driver's seat – the seat is generally suspended. The better way is to evaluate the vertical acceleration that the driver feels.

Verification of the suitability of the designed force-velocity characteristics of the controlled shock absorbers of the axles air suspension of the SOR C 12 intercity bus can be evaluated according to other criteria (e.g., [3], [12]). They are maintaining the ride safety and the road-friendliness (i.e. minimization of the amplitudes of the tire-road contact forces) or minimizing the relative displacement of the engine with respect to the chassis.

Acknowledgements

The article has originated in the framework of solving the Research Plan of the Ministry of Education, Youth and Sports of the Czech Republic MSM4771868401.

References

- [1] D. Danesin, P. Vercellone, F. Mastronardi, M. Fenoglio, A. Fornero, M. Velardocchia, Vehicle dynamics with real time damper systems, 16th European ADAMS User Conference 2001, Berchtesgaden, 2001.
- [2] P. Eberhard, U. Piram, D. Bestle, Optimization of damping characteristics in vehicle dynamics, *Engineering Optimization* 31 (4) (1999) 435-455.
- [3] P. Eberhard, W. Schiehlen, J. Sierts, Sensitivity Analysis of Inertia Parameters in Multibody Dynamics Simulations, Proceedings of the 12th World Congress in Mechanism and Machine Science, Besançon, French IFToMM Committee, 2007, Vol. 4, pp. 101-106.
- [4] L.F.P. Etman, Optimization of multibody systems using approximation concepts, Ph.D. thesis, Eindhoven University of Technology, Eindhoven, 1997.
- [5] M. Ieluzzi, P. Turco, M. Montiglio, Development of a heavy truck semi-active suspension control, *Control Engineering Practice* 14 (3) (2006) 305-312.
- [6] P. Maißer, C.-D. Wolf, A. Keil, K. Hendel, U. Jungnickel, H. Hermsdorf, P.A. Tuan, G. Kielau, O. Enge, U. Parsche, T. Härtel, H. Freudenberg, *alaska*, User manual, Version 2.3, Institute of Mechatronics, Chemnitz, 1998.
- [7] Z. Mastník, Test Report No. 5-21-1004/Mz, BRANO a.s., Jablonec nad Nisou, 2004. (in Czech)
- [8] P. Polach, M. Hajžman, Approaches to the creation of the intercity SOR bus multibody models, Proceedings of the 21st conference with international participation Computational Mechanics 2005, Hrad Nečtiny, FAS UWB in Pilsen, 2005, Vol. II, pp. 477-484. (in Czech)
- [9] P. Polach, M. Hajžman, Design of Characteristics of Air Pressure Controlled Hydraulic Shock Absorbers in an Intercity Bus, Proceedings of III European Conference on Computational Mechanics: Solids, Structures and Coupled Problems in Engineering, Lisbon, LNEC, 2006, CD-ROM.
- [10] P. Polach, M. Hajžman, Design of Characteristics of Air-Pressure-Controlled Hydraulic Shock Absorbers in an Intercity Bus, *Multibody System Dynamics*, 2007. (online first, DOI 10.1007/s11044-007-9055-5)
- [11] K. Rektorys et al., Survey of applicable mathematics, Vol. II, Kluwer Academic Publishers, Dordrecht, 1994.
- [12] M. Valášek, W. Kortüm, Z. Šika, L. Magdolen, O. Vaculín, Development of semi-active road-friendly truck suspensions, *Control Engineering Practise* 6 (6) (1998) 735-744.
- [13] MATLAB[®], Documentation version 7, The MathWorks, Inc., 2004. <http://www.mathworks.com/>