

EMC OF POWER ELECTROTECHNICAL SYSTEMS – ELECTROMAGNETIC COUPLING (PART II.)

PROF. ING. DOBROSLAV KOVÁČ, CSC., DOC. ING. IRENA KOVÁČOVÁ, CSC.
 DOC. ING. ŠTEFÁNIA GALLOVÁ, CSC.

Abstract: *The paper deals with the general analysis of one part of the electromagnetic compatibility (EMC) problem - the electromagnetic coupling applied in the field of power electrical systems. The verification simulation analyses and practical measurements of the electromagnetic coupling, which are confirming the correctness of results obtained from theoretical analyses (part I.), are presented in part II. So they can be used for predictive stating of EMC quality of individual new electrotechnical products.*

Key words: *Electrical electromagnetic compatibility, Electromagnetic coupling, Electrical systems, Electrical drives*

INTRODUCTION

The electromagnetic coupling is typical for galvanically separated electrical circuits, between which exists the exchange of the electromagnetic energy in the form of the radiated and absorbed power. Simulation and measurement of such cases can serve for validity verification of results obtained by theoretical analysis.

1 SIMULATION AND MEASURING

Let's investigate the EMC from the viewpoint of electromagnetic coupling. For this purpose it is satisfactory to analyze the value of resulting vectors \vec{E} and \vec{H} , at the given position, which is created by the superposition of individual vectors \vec{E}_i and \vec{H}_i of power radiated from all the equipments and their parts situated inside the investigated environs. If the circuits of radiated sources are supplied by the non-harmonic currents, then the superposition method of individual harmonic components of Fourier series needs to be applied for the resulting vectors \vec{E} and \vec{H} searching. It is also necessary to keep in mind that the additional induced voltage is developed inside the individual loops of investigated circuit due to electromagnetic coupling existence. These voltages can touch circuit basic functionality. The equipment EMC investigation thus means the voltage value stating in such a way that the question of circuit functionality can be answered and

circuit immunity stated.

$$\begin{aligned}
 u_i &= u_{imag} + u_{ielec} = -\frac{d\psi}{dt} + \int \vec{E} d\vec{l} = -\frac{d\overline{BS}}{dt} + \int \vec{E} d\vec{l} = \\
 &= -\mu_0 S \sum_{i=1}^{m \rightarrow \infty} \frac{\Delta H_i}{\Delta t} \cos \alpha_i + \sum_{i=1}^{m \rightarrow \infty} E_i l_i \cos \beta_i
 \end{aligned} \quad (1)$$

Let the correctness verification of derived equations be done by induced voltage oscillograph measurement inside the circuit connected according to Fig. 1.

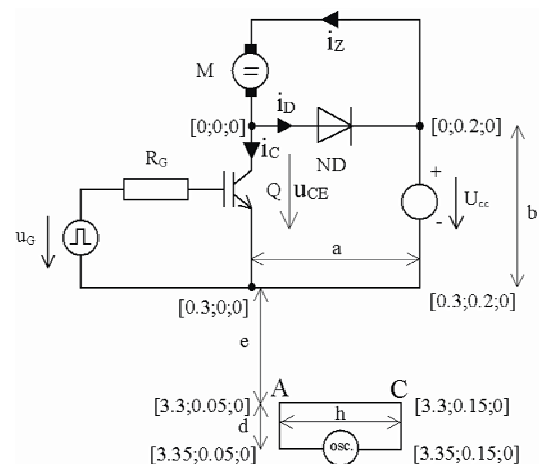

Fig. 1: Investigated circuit scheme

As the source of radiation the one quadrant impulse converter is used with the same working parameters as presented in the previous chapters. Let the circuit location be on the x, y plane. The co-ordinates of Cartesian coordinate system describe individual key points of connection. On the basis of the results obtained from Fourier and transient analyses offered by PSPICE program the DC and the first nine components of Fourier series can express the courses of all power circuit currents and transistor voltage. The final results are presented in figure Fig. 2 and in tables Table. 1 up to Table. 3. Measured courses are pictured in figure Fig. 3.

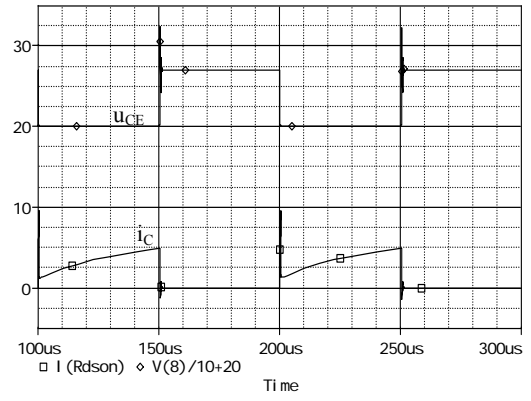

Fig. 2: Transistor voltage and current obtained by simulation

Harmonics	Harmonics	Harmonics	Harmonics	Harmonics
0	1	2	3	4
Amplitude	Amplitude	Amplitude	Amplitude	Amplitude
1.743122	2.36	5.63E-01	6.58E-01	2.89E-01
Phase	Phase	Phase	Phase	Phase
0	-1.87E+01	-1.74E+02	-1.10E+01	1.73E+02

Tab. 1: Coefficients of Fourier series for transistor current i_C

Harmonics	Harmonics	Harmonics	Harmonics	Harmonics
5	6	7	8	9
Amplitude	Amplitude	Amplitude	Amplitude	Amplitude
3.87E-01	1.95E-01	2.75E-01	1.49E-01	2.13E-01
Phase	Phase	Phase	Phase	Phase
-9.68E+00	1.64E+02	-1.02E+01	1.57E+02	-1.13E+01

Tab. 1: Continue

Harmonics	Harmonics	Harmonics	Harmonics	Harmonics
0	1	2	3	4
Amplitude	Amplitude	Amplitude	Amplitude	Amplitude
1.25636	1.739	5.67E-01	6.30E-01	2.90E-01
Phase	Phase	Phase	Phase	Phase
0	-1.56E+02	6.02E+00	-1.74E+02	-6.99E+00

Tab. 2: Coefficients of Fourier series for diode current i_D

Harmonics	Harmonics	Harmonics	Harmonics	Harmonics
5	6	7	8	9
Amplitude	Amplitude	Amplitude	Amplitude	Amplitude
3.81E-01	1.97E-01	2.72E-01	1.51E-01	2.12E-01
Phase	Phase	Phase	Phase	Phase
-1.79E+02	-1.56E+01	1.77E+02	-2.31E+01	1.75E+02

Tab. 2: Continue

Harmonics	Harmonics	Harmonics	Harmonics	Harmonics
0	1	2	3	4
Amplitude	Amplitude	Amplitude	Amplitude	Amplitude
2.999	1.599	5.30E-03	1.92E-01	1.54E-03
Phase	Phase	Phase	Phase	Phase
0	-6.62E+01	-3.27E+01	-8.43E+01	7.54E+00

Tab. 3: Coefficients of Fourier series for load current i_z

Harmonics	Harmonics	Harmonics	Harmonics	Harmonics
5	6	7	8	9
Amplitude	Amplitude	Amplitude	Amplitude	Amplitude
7.00E-02	1.53E-03	3.64E-02	1.35E-03	2.18E-02
Phase	Phase	Phase	Phase	Phase
-8.91E+01	6.86E+00	-9.30E+01	-1.19E+01	-9.60E+01

Tab. 3: Continue

On the basis of the obtained coefficients let the Excel program do the verification synthesis of current courses. The results are introduced in figures Fig. 4 up to Fig. 6. By comparing courses one can state that due to considering only first nine members of Fourier series the peak transistor current generated by the commutation charge of diode was neglected and also the certain undulation was infiltrated. But otherwise its shape is identical with the real measured current course.

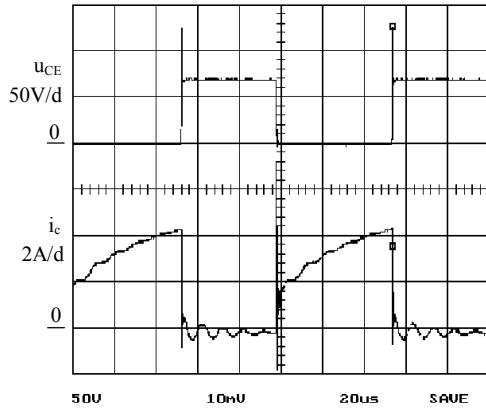

Fig. 3: Measured transistor current and voltage

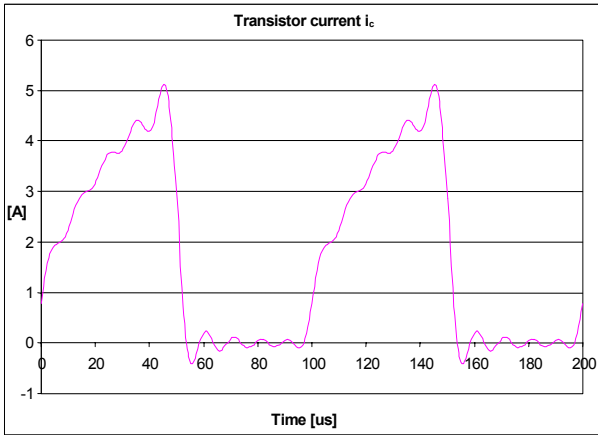

Fig. 4: Transistor current - synthesis by 9 members of Fourier series

By substituting the individual harmonic amplitudes and phases to the Fourier series one can obtain the analytical form of investigated non-harmonic currents. By their application in the equations (23) up to (28) and the equations (37) up to (42) mentioned in part I. it is possible to receive the searched solution for the electromagnetic wave components. The induced voltage generated by the magnetic component of electromagnetic wave can be stated in such a way that

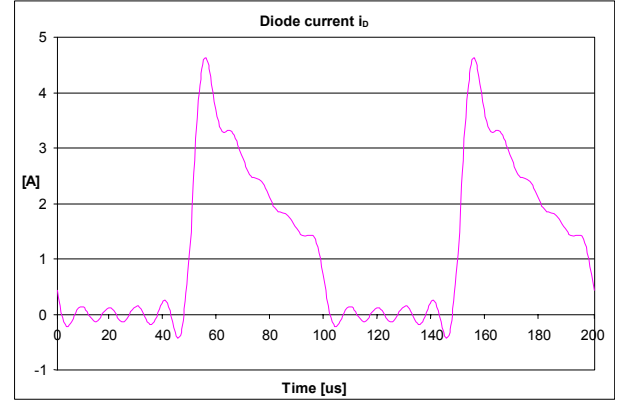

Fig. 5: Diode current - synthesis by 9 members of Fourier series

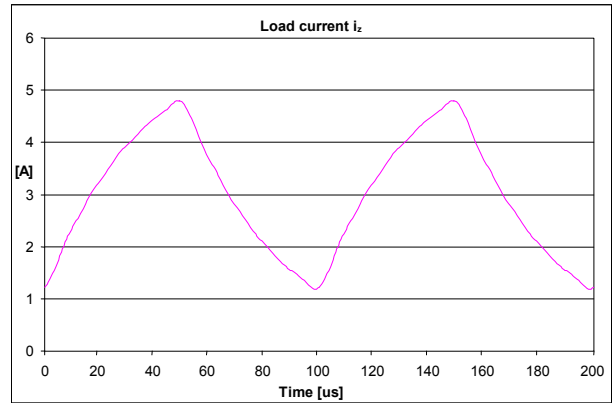

Fig. 6: Load current - synthesis by 9 members of Fourier series

the values of axis components of magnetic intensity vector will be calculated at the position in the center of impacted loop. If the loop dimensions are omissible towards the length of electromagnetic wave, then the magnetic field intensity inside the loop can be allowed to be constant at the given moment and the induced voltage can be calculated according to the equation:

$$u_{imag} = -\mu_0 S \left[\frac{\sqrt{H_x^2(t + \Delta t) + H_y^2(t + \Delta t) + H_z^2(t + \Delta t)}}{\Delta t} - \frac{\sqrt{H_x^2(t) + H_y^2(t) + H_z^2(t)}}{\Delta t} \right] \quad (2)$$

where S is the surface of impacted loop which represents the impacted electrical circuit.

The induced voltage generated by the electric component of electromagnetic wave can be stated in such a way that the values of axis components of electric intensity vector at the positions A[3.3;0.05;0] and C[3.3;0.15;0] will be found. The induced voltage value then should be calculated on the basis of the well-known relation from the field of theoretical electrical engineering; however, only if we take into consideration the fact that the moving electromagnetic wave changes its own intensity by the value ΔE_x (or ΔE_y) during its transition time $\Delta t' = d/c$ (or $\Delta t'' = h/c$) along the investigated loop.

$$\begin{aligned}
u_{ielec} = & (E_{xA}(t + \Delta t') - E_{xA}(t))d + \\
& + (E_{xC}(t + \Delta t') - E_{xC}(t))d + \\
& + (E_{yA}(t + \Delta t'') - E_{yA}(t))h + \\
& + (E_{yC}(t + \Delta t'') - E_{yC}(t))h
\end{aligned} \quad (3)$$

Resulting induced voltage, calculated as the superposition of its magnetic and electric compounds, does not provide satisfactory graphical representation in analytical form. The numerical method of searching time depending solution and the graphical presentation are more advantageous in this case because the computer programs currently available, for example, the Excel program, allow its application very easily. On the basis of the previous equation calculations, which were done for two periods of basic harmonics, one can obtain the graphical interpretation of resulting induced voltage inside the impacted loop, which is shown in the following Fig. 7. The measured course of induced voltage is presented in Fig. 8.

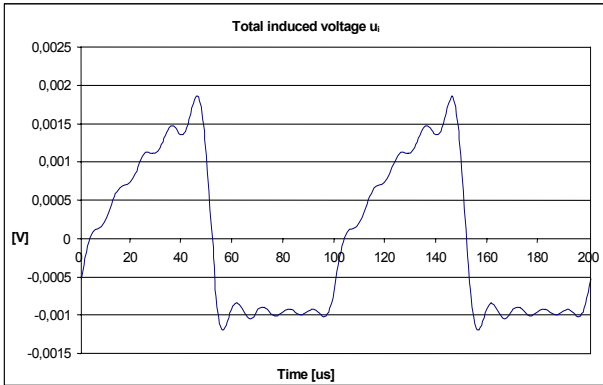

Fig. 7: Calculated course of total induced voltage u_i inside the investigated loop

By comparing the simulated and measured results one can find out that positive amplitudes reach approximately the same values 1.8 mV and similarly the negative amplitudes have the values 1 mV. The existing ripple and the absence of short positive voltage impulse with the amplitude 2.5 mV inside the induced voltage course obtained by simulation is caused by considering only the first nine components of Fourier series. Generally it is possible to say that there exists a relatively great coincidence between the simulated and measured results. Thus the correctness of derived equations is confirmed as

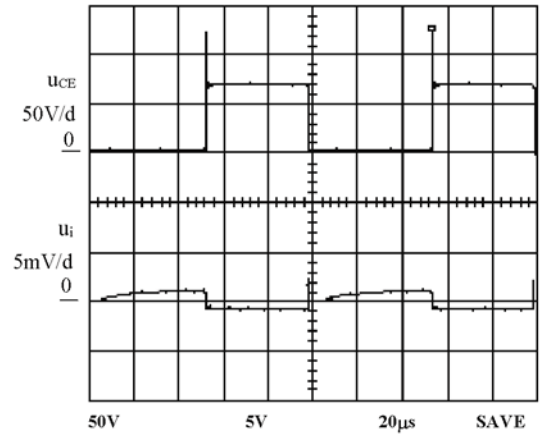

Fig. 8: Measured course of total induced voltage u_i

well as the fact that if higher number of Fourier series components are used the better coincidence of both type results will be obtained. It means that during the electromagnetic coupling investigation, as one part of general EMC investigation, it is necessary to reconsider the compromise between the number of Fourier series components and the required calculation precision.

2 CONCLUSION

The above-mentioned simulated and measured results are sufficiently identical with the theoretical results published in part I. and so they confirm the correctness of derived equations. Such a way they can be used for predictive stating of EMC quality of individual new electrotechnical products.

Based on the performed analysis also we can find out that the intensity of electromagnetic coupling is directly proportional to the amount and the time change slope of circuit current, which is radiating the electromagnetic energy. In the same way electromagnetic coupling intensity depends on the length of this circuit. It is also directly proportional to the surface and the length values of disturbed circuit. It is indirectly proportional to the distance between the interference source and the disturbed circuits, to the reflection coefficient and to the permeability and permittivity values of space between the both circuits.

The reduction of amount and the velocity change of current flowing inside the circuit transmitting the electromagnetic energy can be realized only if it is not in contradiction with its functionality requirements. It is evident that power electrotechnical systems are embosomed with the greater electric and magnetic field than the low power equipments. It is necessary to eliminate the impact of these fields acting on the ambient systems. Besides the requirement of working frequency reduction, the shielding principle of systems is also used very often in practice, thus the smaller disturbing induced voltage should be reached. According to the Table 1 in part I. it can be stated that if the frequency is lower, the electromagnetic wave damping coefficient β is lower too and the penetration depth δ is higher. It means that on the one hand the created induced voltage is lower, but on the other hand the low frequency electromagnetic field shielding is more complicated and the shielding cover

layer must be a lot thicker. From this viewpoint it seems better to choose the higher switching frequencies with the carefully designed effective shielding cover for the big current switching in the field of power electronics.

The length shortening of radiated circuit can be realized only by miniaturization of such circuits, which could possibly be the source of interference electromagnetic signals. However, this solution is possible to use only in the development stage of equipments. The exploitation of non-potential integrated modules of power semiconductor converters can be the specimen example of positive problem solution. This realization is very difficult to realize economically and usually also technically as a supplementary solution.

The reduction of disturbed circuit length and surface by increasing modern electrotechnical systems integration density is another way to improve EMC of the given equipment. If the impacted system has the small volume it usually also has the small surface, through which the interference energy penetrates into its interior. This direct proportion logically means the higher immunity of such equipment, too.

The enlargement of transmitting and receiving circuit distance is a standard solution of mutual circuit interference. However, in the case of electromagnetic wave coupling the specific problem arises concerning the frequency dependence of extension and the specific damping coefficients and the principle of such form energy transfer utilizing at the long distances for the telecommunication technique purposes. Due to this fact the mentioned method of improving EMC of the electrotechnical system is usually combined with the alternative methods.

The enlargement of wave reflection coefficient, the specific damping coefficient and the permeability and permittivity values of space between both circuits is usually realized in practice by the shielding cover of equipment transmitted interference energy and also by the shielding cover of disturbed equipment. In the majority of cases, it is made of sufficiently robust, highly conductive and quality magnetic material, the task of which is to create the effective barrier against the electromagnetic wave penetration. If the cover thickness is not sufficient, then the absorption of penetration wave component is only partial and it means that the wave is radiated farther, but with the reduced intensity. Besides the sufficient thickness of cover it must also be constructed without outlets, which could represent the independent transmitting sources deteriorating the EMC of the given equipment. The metal self-adhesive tape, conductive mastics, glues, lamellas, sealing materials and the other supplements, can realize the elimination of all possible technological cover outlets. The requirement concerning mutual highly conductive interconnection of all cover parts, including the mobile and dismountable ones, should also be met. In order to improve the system EMC, the principle of wave reflection on the surface undulations, besides the principle of wave damping, is applied. Therefore the covers are not constructed with the smoothed surface, but they are painted using the conductive color, which creates certain surface relief.

3 ACKNOWLEDGEMENTS

The paper has been prepared under the support of Slovak grant project No. 1/4174/07.

4 REFERENCES

- [1] Kováčová, I., Kováč, D., Kaňuch, J.: EMC from the look of theory and practice. BEN technical literature, s.r.o., Praha, 220 pages, 2006.
- [2] Kováč, D., Kováčová, I., Šimko, V.: Analysis of Electric Circuits I. Akris, Košice, 189 pages, 2001.
- [3] Bendl, J., Chomát, M., Schreier, L.: Analysis of Rotor and Stator Currents in Doubly Fed Machine Supplied from Cycloconverter. University of West Bohemia, AMTEE 2005, International Conference on Advanced Methods in The Theory of Electrical Engineering, Pilsen (CZ), 10.-12.09.2003, pp. D13-D18.
- [4] Kováčová, I., Kováč, D.: EMC of DC Electrical Drives - Inductive Coupling. Acta Technica CSAV, Vol. 50, No.3, 2006, pp. 269-278.
- [5] Kús V.: Influence of Semiconductor Converters on Feeding Net. BEN technical literature, s.r.o., Praha, 2002.
- [6] Kováč, D., Kováčová, I.: Power transistors MOSFET and IGBT. Elfa, s.r.o., Košice, 189 pages, 1996.
- [7] Mayer, D., Ulrych, B., Škopek, M.: Electromagnetic Field Analysis by Modern Software Products. Journal of Electrical Engineering, Vol. 7, No.1, 2001.
- [8] Kováčová, I., Kováč, D.: EMC Compatibility of Power Semiconductor Converters and Inverters. Acta Electrotechnica et Informatica, No.2, Vol.3, pp.12-14, 2003.
- [9] Göksu, H., Wunsh, D. C.: Neural Networks Applied to Electromagnetic Compatibility Simulations. Lecture Notes in Computer Science, Springer - Verlag GmbH, Vol. 2714, pp. 1057-1063, 2003.
- [10] Kováčová, I., Kováč, D.: Converter's EMC - Capacitive Coupling and Parasitic Capacitances. Advances in Electrical and Computer Engineering, Vol. 5, No.1, pp. 25-32, 2005.
- [11] Valouch, V., Škramlík, J., Doležel, I.: High-Frequency Interferences Produced in Systems Consisting of PWM Inverter, Long Cable and Induction Motor. Automatika 1/2, 2001, Croatia, pp. 45-51.
- [12] Kováč, D., Kováčová, I.: Influence of Utilizing Static Power Semiconductor Converters on Quality of Electrical Power Line Parameters. Quality - Innovation - Prosperity, No.1, 2001, pp.74-84.

Dobroslav Kováč, Prof., Ing., CSc., Department of Theoretical Electrotechnics and Electrical Measurement, FEI, Technical University of Košice, Park Komenského 3, 042 00 Košice, Slovak Republic, e-mail: dobroslav.kovac@tuke.sk.

Irena Kováčová, Doc., Ing., CSc., Department of Electrotechnics, Mechatronics and Industrial Engineering, Technical University of Košice, Letná 9, 042 00 Košice, Slovak Republic, e-mail: irena.kovacova@tuke.sk.

Štefánia Gallová, Doc., Ing., CSc., Department of

Automation and Control Engineering, Sjf, Technical
University of Košice, Letná 9, 042 00 Košice, Slovak
Republic, e-mail: stefania.gallova@tuke.sk