

# Programmable Generator of External Triggering Signal

For Dantec PIV Timer Box 80N77

Milan Guštar, Pavel Dlask  
Musical Acoustics Research Centre  
HAMU, Academy of Performing Arts in Prague  
Prague, Czech Republic  
milan.gustar@hamu.cz, pavel.dlask@hamu.cz

**Abstract** – The Programmable generator of external triggering signal facilitates the automated recording of (quasi-) periodic or repeated physical processes. The device allows for the unmanned activation and tracking of the physical process and the control of connected recording system. The device automatically changes selected record parameters in a sequence of repeated measurement steps.

**Keywords** - synchronizer; recording; measurement; particle image velocimetry

## I. INTRODUCTION

Particle image velocimetry (PIV) is a whole-flow-field technique providing instantaneous velocity vector measurements in a cross-section of a flow. The measurement consists in camera recording (high-speed digital cameras are usually used) of tracer particles added to the flow and illuminated by means of a laser in a plane of this flow at least twice within a short time interval (see e.g. [1]). If the air flow is investigated, oil drops of size from 1  $\mu\text{m}$  to 5  $\mu\text{m}$  are usually used as the particles being traced. The camera recording and the laser illumination have to be synchronized.

In the double-frame PIV variant the investigated area (the slice of the volume where the tracer particles are randomly distributed) is repeatedly illuminated by a pair of laser light pulses and corresponding images (frames A and B) are recorded using the camera, see Fig. 1. The time interval  $\Delta t$  between the A and B frames (see Fig. 1) should be adjusted according to the average flow velocity, the interrogation area size (see [2]), and the properties of the optical system being used. The double-frame images sequence forms the acquired datasets (one measurement, labeled as “image ensemble” in Dynamic studio database) [2]. Displacement vectors used for velocity field calculation are determined and calculated using a special correlation algorithm on the A-B pairs (see e.g. [1, 2] for further explanation and commentary). The double-frame PIV variant was used for the measurements described below.

The Dantec PIV system equipped with the Timer Box 80N77 synchronizer unit was used for the measurements. The synchronizer unit serves for the camera and laser synchronization. With the aid of the Dynamic studio control and analysis software version 3.41 the system allows several synchronization setups [2].

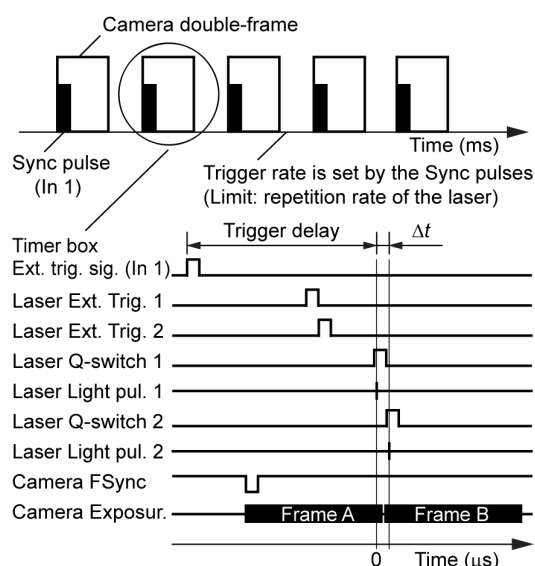

Figure 1. Timing diagram of the presented system synchronization setup in double-frame PIV variant.

In the *External synchronization mode with internal trigger* the internal trigger rate is derived from the external Sync signal (External trigger signal connected to the Timer Box Input port 1), see Fig. 1. However, only a constant Trigger delay (the delay between the external trigger signal and the first laser light pulse, see Fig. 1) can be selected for each measurement.

When a slow laser (double pulses repetition rate is in the order of tens of Hz) is used for a continuous recording of a (quasi-) periodic flow, it is necessary to carry out multiple measurements with gradually changing trigger delays. Even with the use of the Acquisition Manager (which is part of Dynamic studio software, see [2]) the total acquisition time is long (after each measurement the acquired datasets are saved to the database and a new initialization takes place), there is a risk of operating errors possibly resulting in the necessity of measurement repetitions, and the datasets structure of the measurements (ensembles) is not suitable for subsequent processing in the Dynamic studio (version 3.41).

Using the Programmable generator of external triggering signal (connected to the Timer Box Input port 1) producing an appropriately defined sequence of triggering pulses, the investigated flow can be recorded and saved as a single measurement (datasets)

with the datasets structure similar to the one of a time-resolved PIV, see e.g. [1, 2] (assumption of the sufficient periodicity or good repeatability of the measured phenomenon is held through the article). This method is known as the phase-locked PIV and, in essence, it allows to perform required time domain measurements of (quasi-) periodic flow in the phase domain.

## II. THE DEVICE

The basis of the device is an Arduino UNO single-board microcomputer fitted with a custom-made daughter-board with input and output circuitry. All the signal inputs and outputs operate at TTL levels 5 V and are connected to BNC connectors. The Ctrl output is connected to the relay contacts and serves for the monitored process control.

The device is connected to a USB port of the computer equipped with a character terminal program which serves for the operating mode selection and for the entering all parameters. Main device functions are controlled by push-buttons. The device is USB-powered, no external power supply is required.

The device can be operated in one of two distinct modes (*phase-locked mode* or *single-shot mode*) each of which has two variants.

### A. Phase-locked mode

In the phase-locked measurement mode, the device generates a sequence of Trig pulses synchronized with the investigated (quasi-) periodic process. A signal derived from the ongoing (quasi-) periodic process is fed to the device Sync input and serves as a synchronization source for the device.

In the *one-shot-per-phase option*, the device changes the phase shift between Sync and Trig signals gradually and one double-frame image is acquired for each phase shift. After all images for the entire period of the observed event are acquired, the measurement can be automatically repeated several times, see Fig. 2. In this option, the acquired datasets structure is similar to the one of a time-resolved PIV.

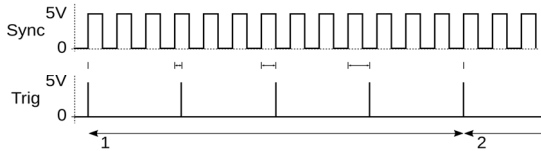

Figure 2. One-shot-per-phase timing diagram (four phases, repeated measurements).

In the *repeated-shots-per-phase option*, the device changes the phase shift to obtain the specified number of double-frame images for each phase shift, see Fig. 3. This option is similar to the Dantec Acquisition Manager function, but the total acquisition time is much shorter and therefore many measurement interrupts (such as the ones due to necessary cleaning of system transparent parts) are eliminated.

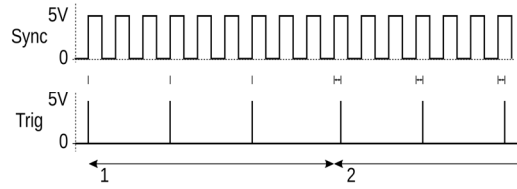

Figure 3. Repeated-shots-per-phase timing diagram (phase-shifts 1 and 2 repeated three times).

### B. Single-shot mode

In Single-shot measurement mode, the device repeatedly triggers the monitored process using the Ctrl output signal and generates Trig pulses synchronized with the process beginning. The Sync input is not used in this mode of operation. Each time the monitored process is initiated, the device automatically changes the time interval (delay) between the Ctrl and Trig signals.

In the *one-shot-per-step option*, one double-frame image is taken for each time delay, see Fig. 4.

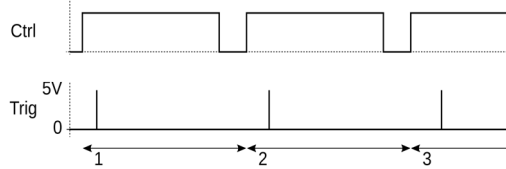

Figure 4. One-shot-per-step timing diagram (steps 1, 2 and 3).

In the *multiple-shots-per-step option*, the selected number of double-frame images is taken in each run, see Fig. 5. The delay between subsequent double-shots is constrained by the limitations of the recording device (laser charging, etc.). This option imitates the Acquisition Manager function again, as in the case of the *repeated-shots-per-phase option*. The total acquisition time is shortened similarly.

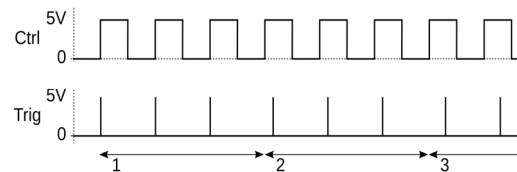

Figure 5. Multiple-shots-per-step timing diagram (three shots in steps 1, 2 and 3).

## III. EXAMPLE: AIRFLOW IN THE ORGAN PIPE

As an example of the device use the measurement of the airflow in the organ pipe is presented.

The Fig. 6 shows the measurement setup, which allows the continuous (time-ordered) recording of the flue organ pipe airflow in the steady (quasi-) periodic state of operation as well as the initial transient state.

The initial non-periodic transient state is measured in the *Single-shot mode*. In the periodic steady state the airflow and the sound field oscillations inside the pipe are synchronous, the process has suitable time periodicity and therefore the *Phase-locked mode* can be used.

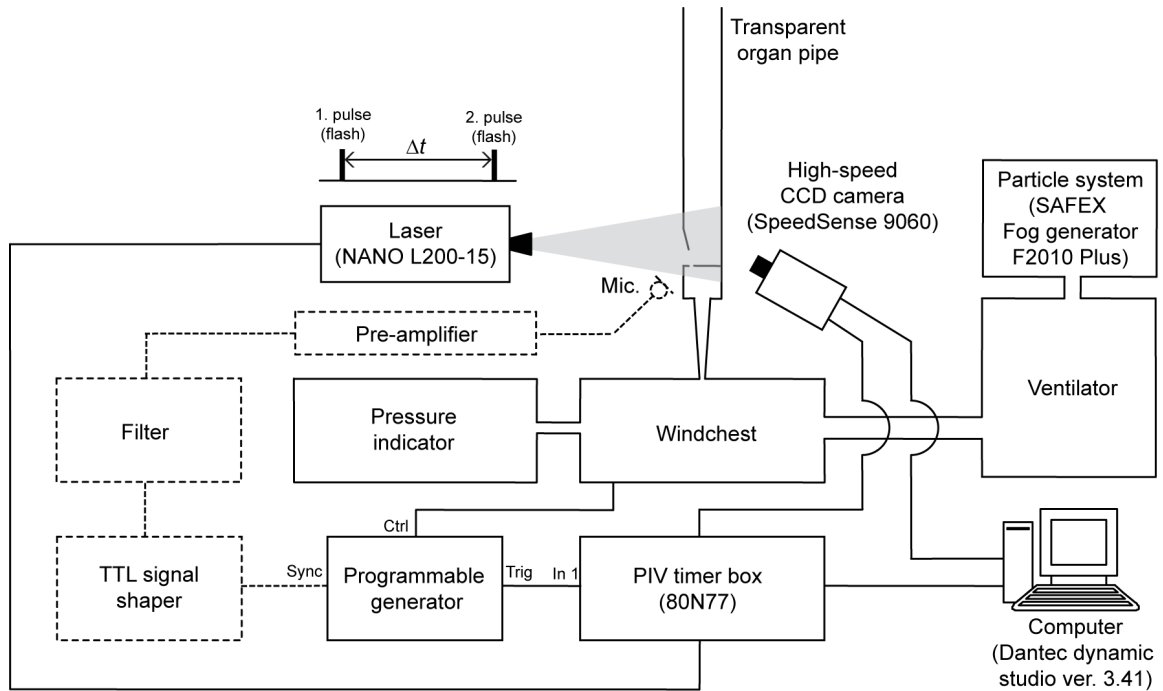

Figure 6. The Dantec PIV system setup for the measurement of the (quasi-) periodic state as well as the initial transient state of the airflow (flue organ pipe jet in this case) with the aid of the described Programmable generator. Parts marked by the dashed line are not used for the initial transient state measurement. The maximal laser repetition rate is 15 Hz.

Manually controlled operation requiring multiple measurements (by means of the Dantec Acquisition Manager) with gradually changing delays was time consuming, the process had to be frequently interrupted due to transparent parts cleaning, some measurements had to be repeated due to human errors, etc. Data saved in the Dynamic studio database as individual measurements (ensembles) had to be exported to the MATLAB or other data processing software to be analyzed in the phase or time domain (e.g. by the Bi-Orthogonal Decomposition, see e.g. [2, 3]).

The Programmable generator of external triggering signal was developed to optimize the measurement process.

In the modified measurement apparatus setup the device Ctrl output relay contacts serve to control the organ pipe valve, a rectangular signal fed to the Sync input is derived from the waveform from a microphone located near the pipe, and the device Trig signal is fed to the Timer Box Input port 1, see Fig. 6.

The automated operation controlled by the device led to significant speed-up of measurements and subsequent data analysis and post-processing.

#### IV. DISCUSSION & CONCLUSIONS

The Programmable generator of external triggering signal was designed and developed as an add-on device to the Dantec PIV system equipped with the Timer Box 80N77 synchronizer unit with the aim to speed-up and simplify the measurement process and subsequent data processing.

The automated PIV system controlled by the Programmable generator of external triggering signal in the *Phase-locked mode* (*one-shot-per-phase* options) as well as the *Single-shot mode* (*one-shot-per-step* options) was used for the unstable flow in the flue organ pipes measurement. The acquired datasets structure was similar to the one of the time-resolved PIV. The significant speed-up of data acquisition, analysis and post-processing was achieved, the human errors were minimized, and the overall reliability of the whole process was increased.

The device was designed to simplify the recording and analyzing the airflow in the flue organ pipe, but it can be used for many other types of measurements requiring gradually changing sequences of synchronizing pulses directly or with minimal hardware or software modifications.

The example of the Dantec PIV system measurement results of the flue organ pipe jet (quasi-) periodic state with the fundamental frequency  $f_0 = 111$  Hz (phase-locked method) is presented in Fig. 7. Data acquired using the generator of external triggering signal are in Fig. 7a and the ones without the generator in Fig. 7b. Since the specific tracer particles distributions and their changes among the double-frames images (datasets) are hard to be evaluated visually, the calculated velocity fields [1, 2] are presented. The results show that the combination of the slow laser (with the repetition rate of 15 Hz) and the generator allows to acquire a similar datasets structure within a single measurement as the time-resolved PIV would provide. However, a fast laser with the repetition rate of about 1 kHz would be required to acquire the comparable datasets structure.

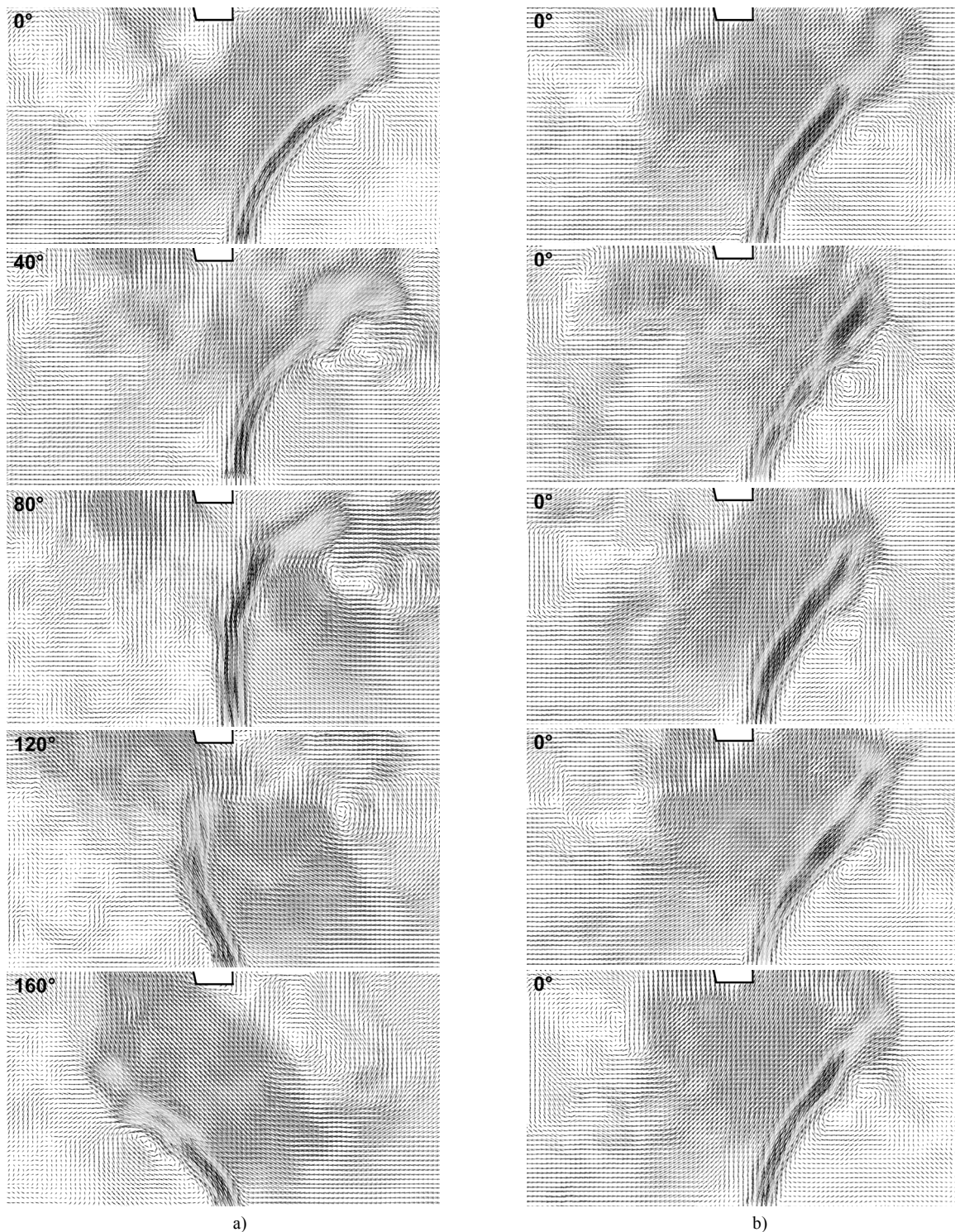

Figure 7. The comparison of the Dantec PIV system measurement results a) with the generator of external triggering signal in *phase-locked mode (one-shot-per-phase option* with phase step  $40^\circ$ ) and b) without the generator. The calculated velocity fields (by Adaptive PIV analysis method [2]) of the first five double-frame images (datasets) acquired from the measurement of the flue organ pipe jet (quasi-) periodic state ( $f_0 = 111$  Hz), see Fig. 6, are presented. The laser repetition rate was 15 Hz and the value of the trigger delay was set to 500  $\mu$ s.

#### ACKNOWLEDGMENT

This publication was written at the Academy of Performing Arts in Prague as a part of the project “Sound Quality” with the support of the Institutional Endowment for the Long Term Conceptual Development of Research Institutes, as provided by the Ministry of Education, Youth and Sports of the Czech Republic.

#### REFERENCES

- [1] M. Raffel, C. Willert, S. Wereley, and J. Kompenhans, Particle Image Velocimetry, 2nd ed., New York: Springer, 2007
- [2] Dantec, Dantec Dynamics Resources [online], 2013 [cit. 2018-03-13], Available from: <http://www.dantecdynamic.com>
- [3] V. Uruba, Decomposition Methods in Turbulence Research, EPJ Web of Conferences 25, 2012
- [4] Arduino [online], [cit. 2018-03-13], Available from: <https://www.arduino.cc/>