

TRO







1.

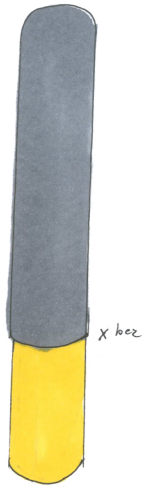
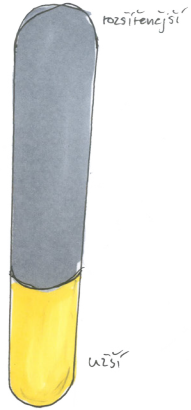
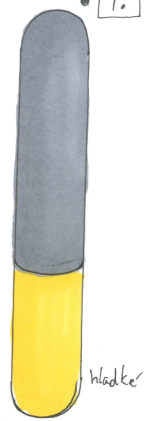

2.



tenší prodloužené  
(délka 1m)

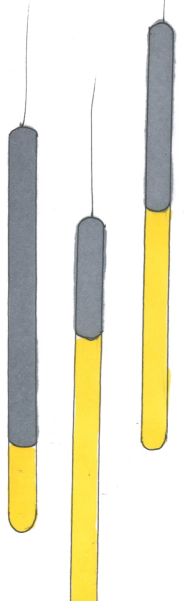

vroučky?

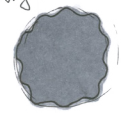

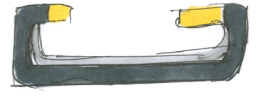
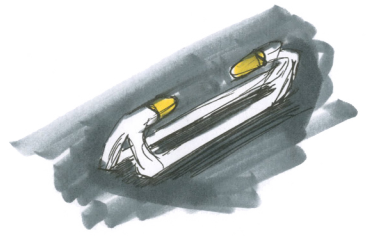
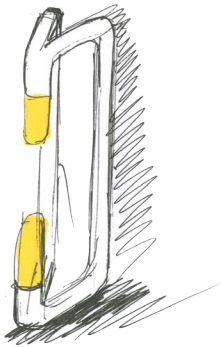
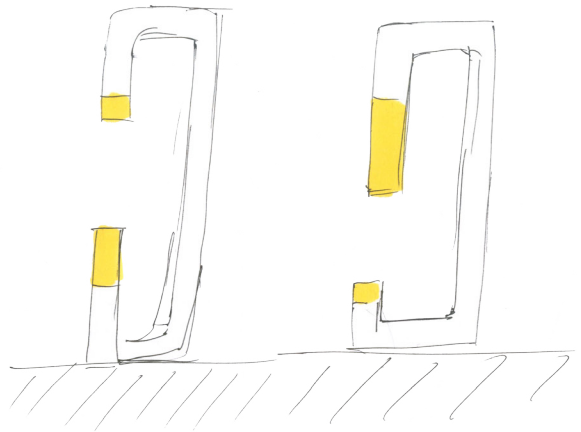
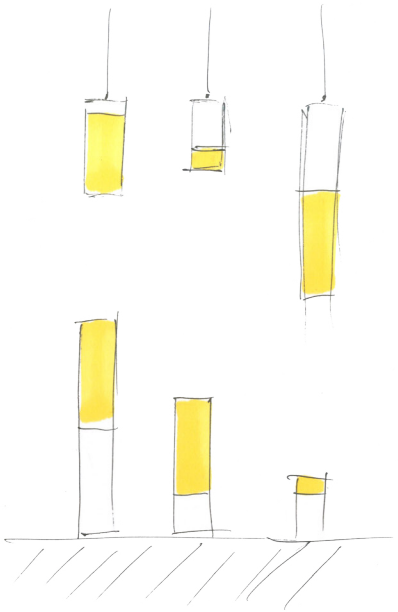
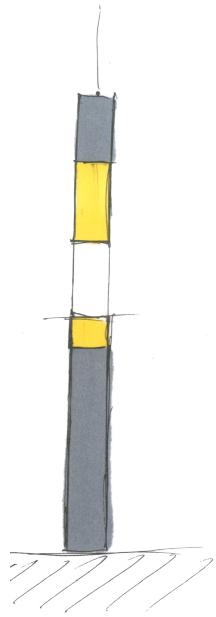

↳ dalo by se i položit

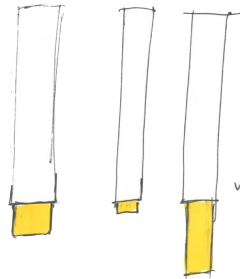
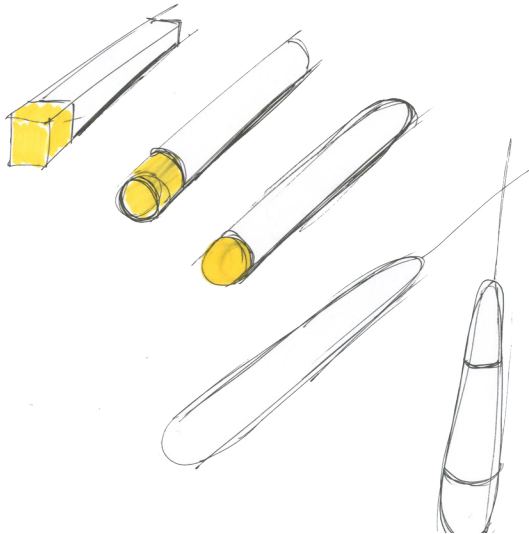
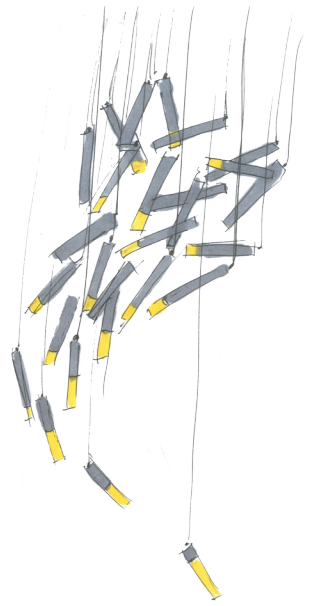
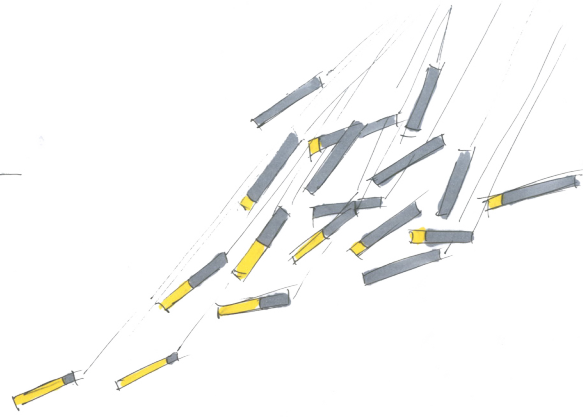
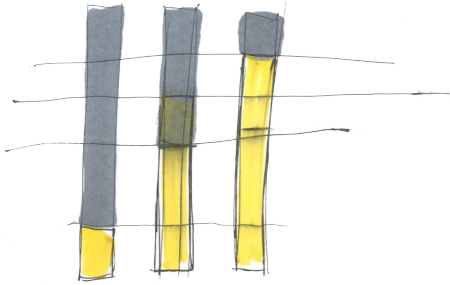

vstupující ?

X změna velikosti ?  
→



velká změna tvaru

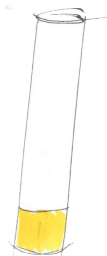
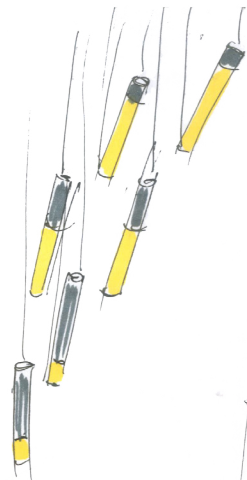
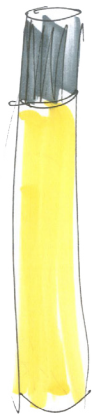
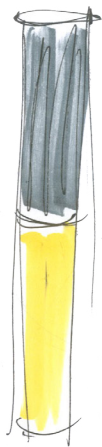

vystrežené  
odstupňování

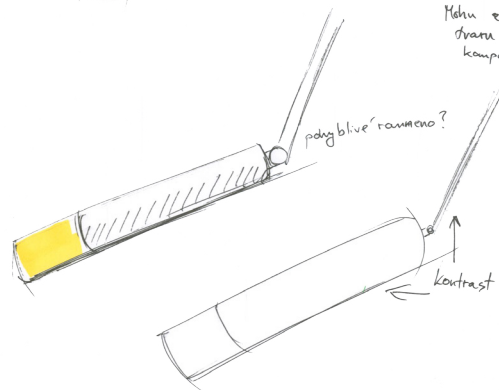

Mohu zůstat u jednoduchého  
tvary za předpokladu, že  
kompozice skupiny?

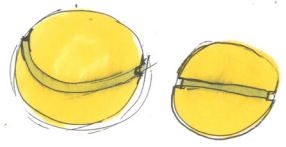
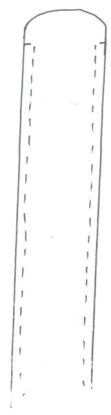
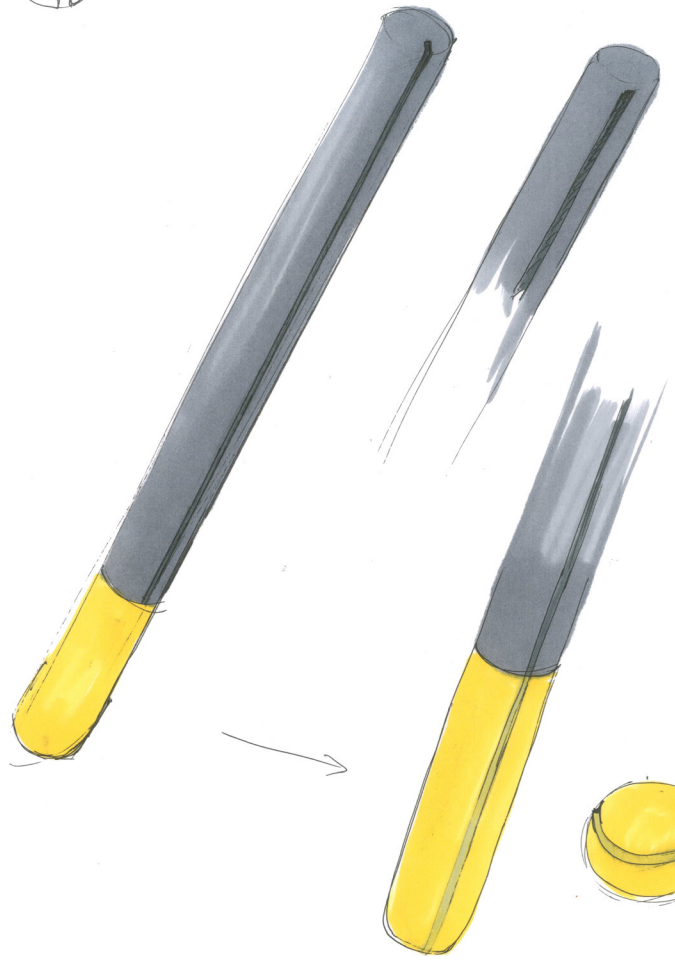
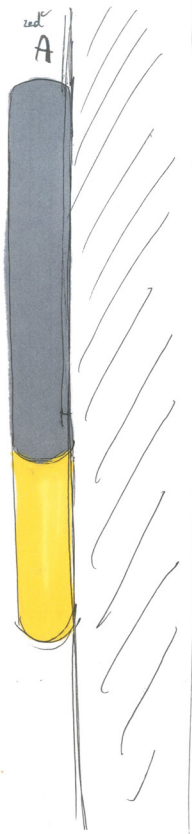



(A)

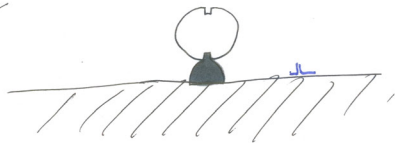
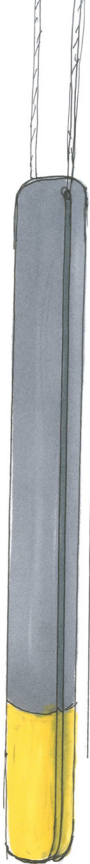

X



X

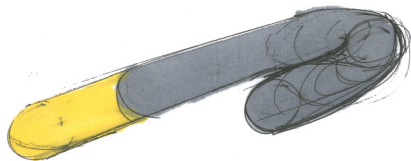

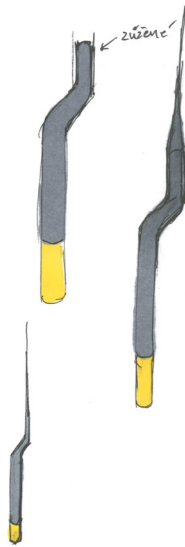
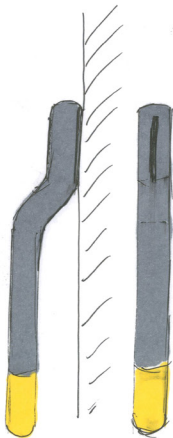
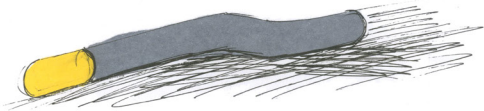

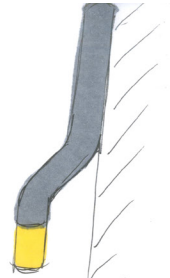
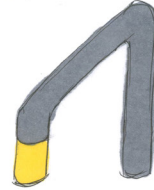
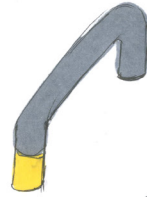
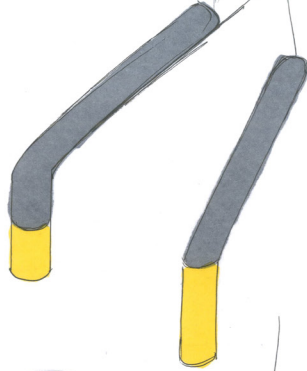
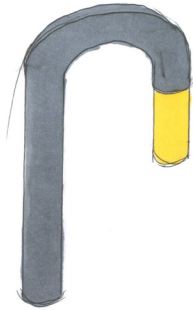
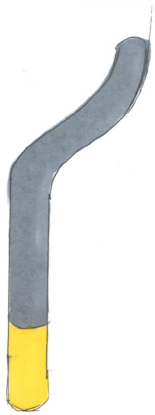

dve  
moznosti

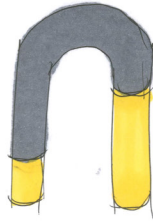
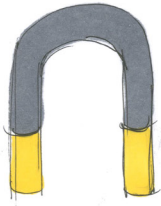
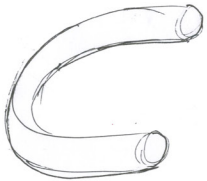
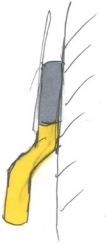

Jeden typ

⇒ tri možnosti

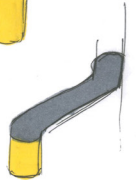
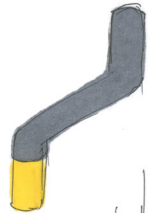
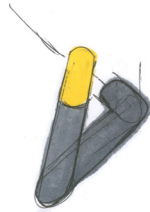
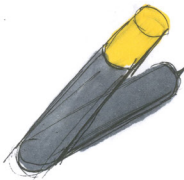





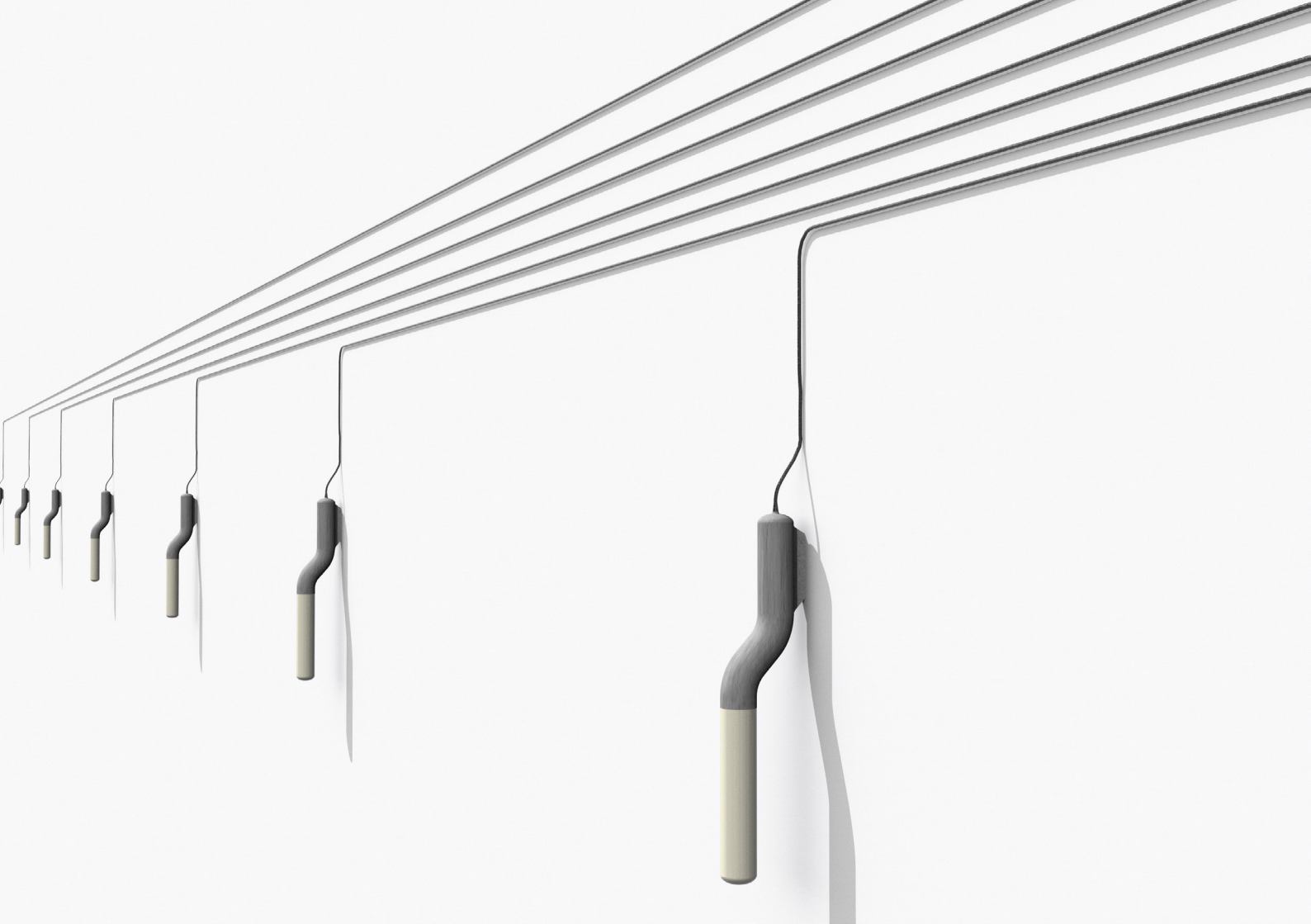









103

15



2 4 5

608

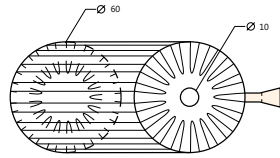
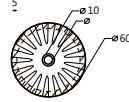
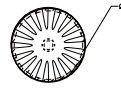

7

290 156

126

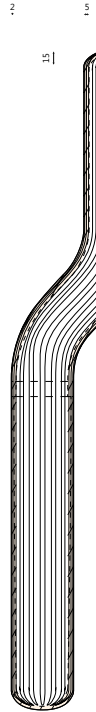

15

2 5

71.21

102 11.15 8

607

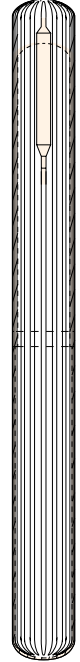

15

5 0

136

341

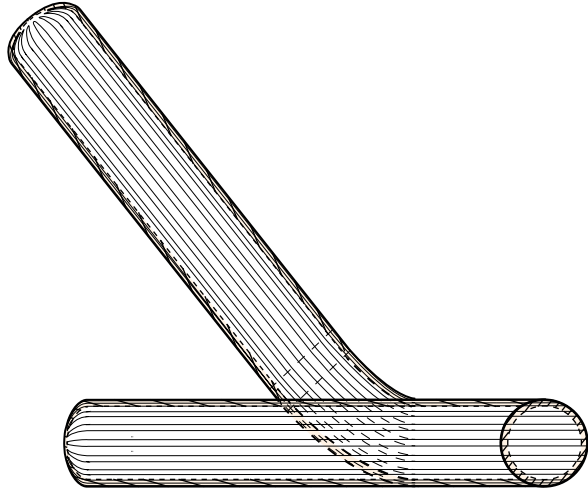

15

355

95

156

142

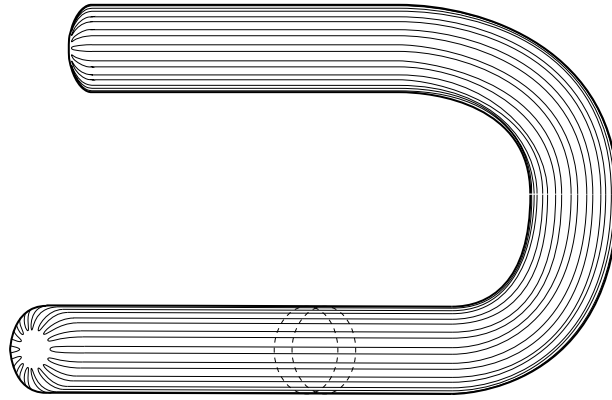

15

2

4

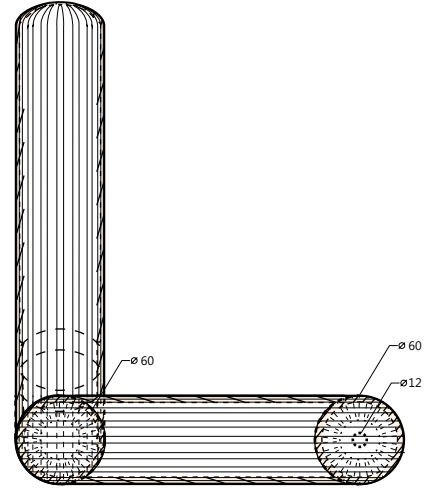

Ø 60

Ø 60

Ø 12

433





